



VEHICLE-MOUNTED COMPUTERS

Configuration & Accessories Guide

VH10, VC70, VC80, VC80x, VC8300

Glacier Computer
New Milford CT - Amherst NH

sales@glaciercomputer.com
603-882-1560 x6

Zebra Vehicle Mounted Computers

Product Family



Windows 7/10



Windows CE



Android



**FOUR PLATFORMS... THREE FORM FACTORS...
THE SAME ACCESSORIES, RUGGEDNESS, AND RELIABILITY**

Vehicle Mounted Computers

Configuration & Accessories Guide

- The Zebra Technologies portfolio of accessories extends the capabilities of your **VH10**, **VC70**, **VC80**, **VC80x** or **VC8300**, and enables you to lower the cost of ownership of your Zebra mobile computer.
- This simple step-by-step guide is designed to assist you with the selection of your accessories based on your needs and use of the computers.



VEHICLE-MOUNTED COMPUTERS

Install Illustration

STEP	ACCESSORY	SLIDE
1	Power Supplies & Cables	6-14
2	Mounts	15-19
3	Scanners	20-22
4	Keyboards	23-25
5	Antennas	26-28
6	Voice	29-30
7	Miscellaneous	31-32
8	Service Parts	33-35

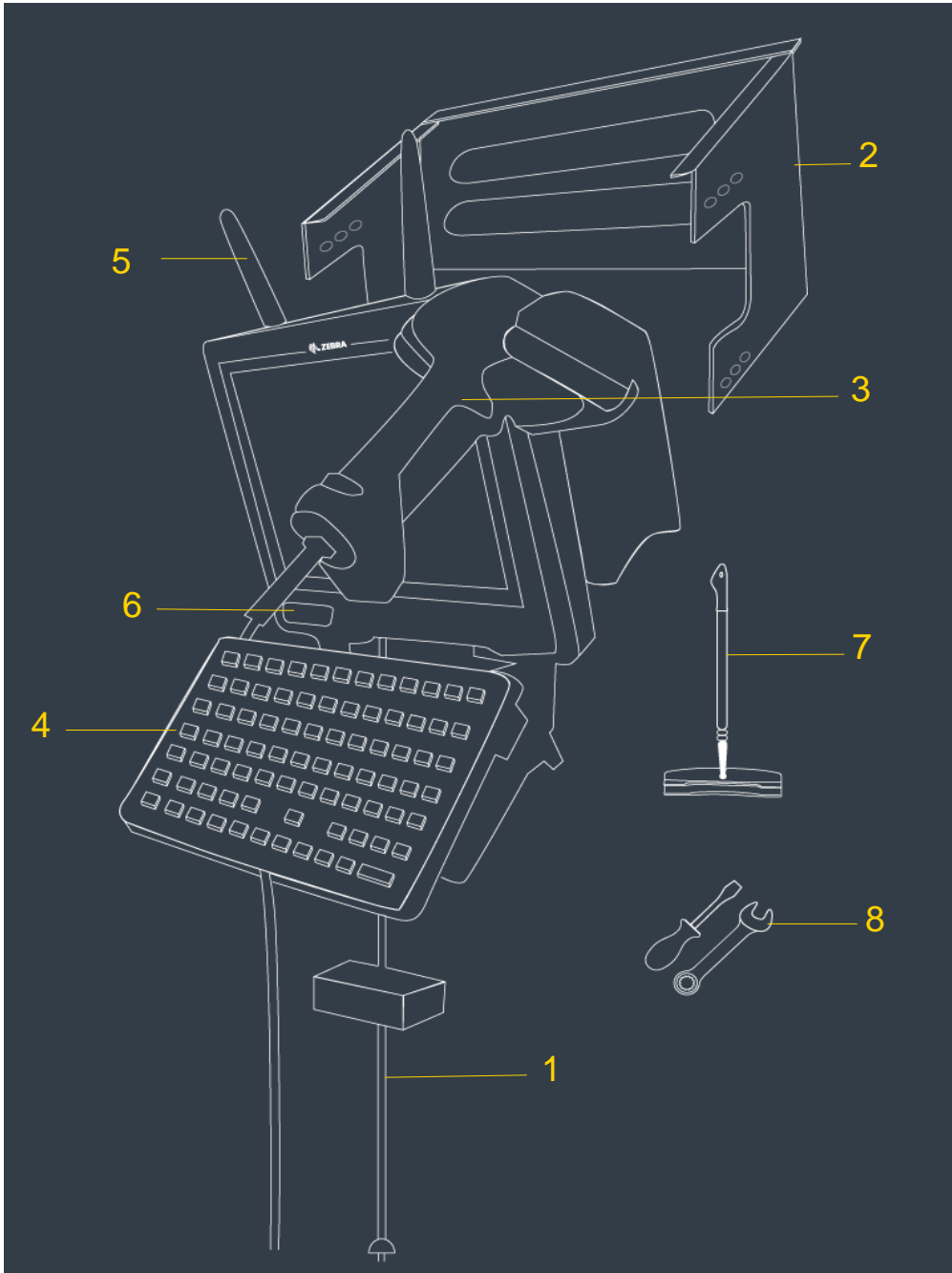

Step 1: Power Supplies and Cables



Choose from multiple installation cases

- Plug into an AC wall outlet
 - VH10, VC70, VC80, VC80x, VC8300 (Slide 6)
- Plug into the Vehicle's DC power
 - VC70 (Slides 7-9)
 - VH10, VC80, VC80x, VC8300 (Slides 10-14)



Glacier Computer

603.882.1560 Ext. 6

sales@glaciercomputer.com

www.glaciercomputer.com

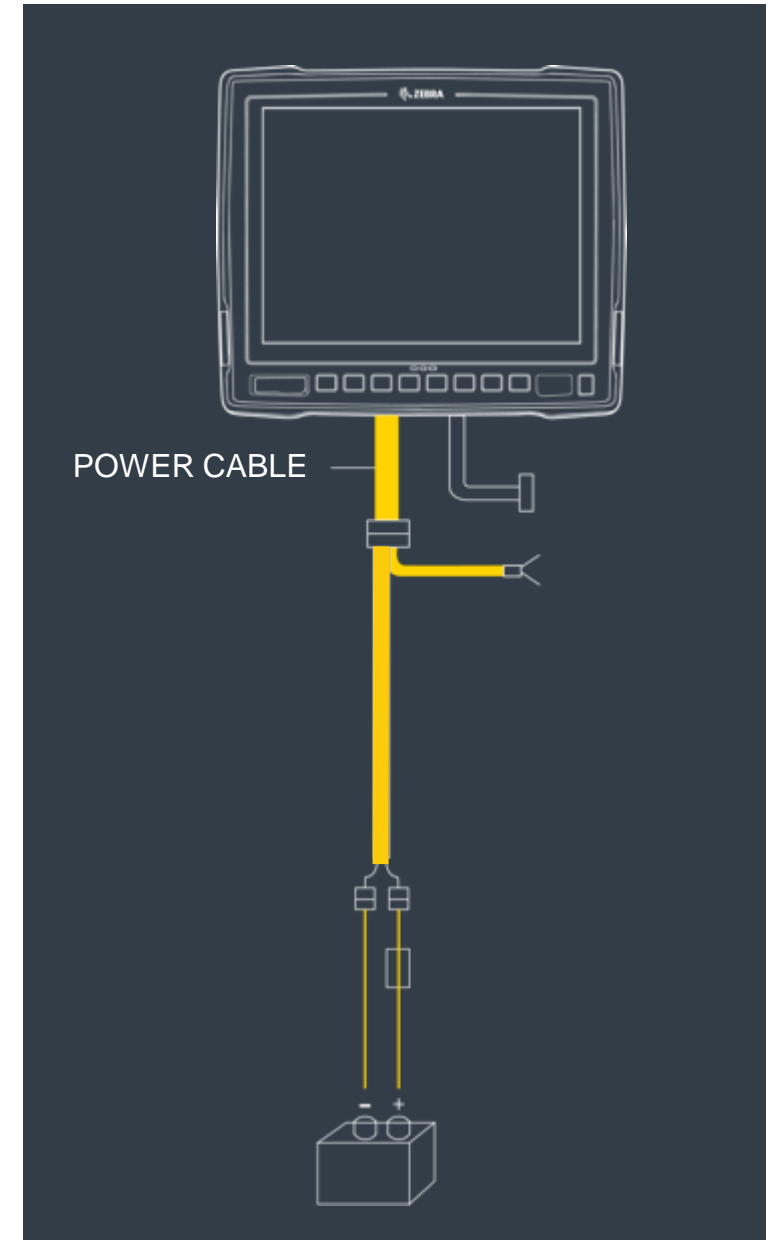

Step 1

Power Supplies & Cables

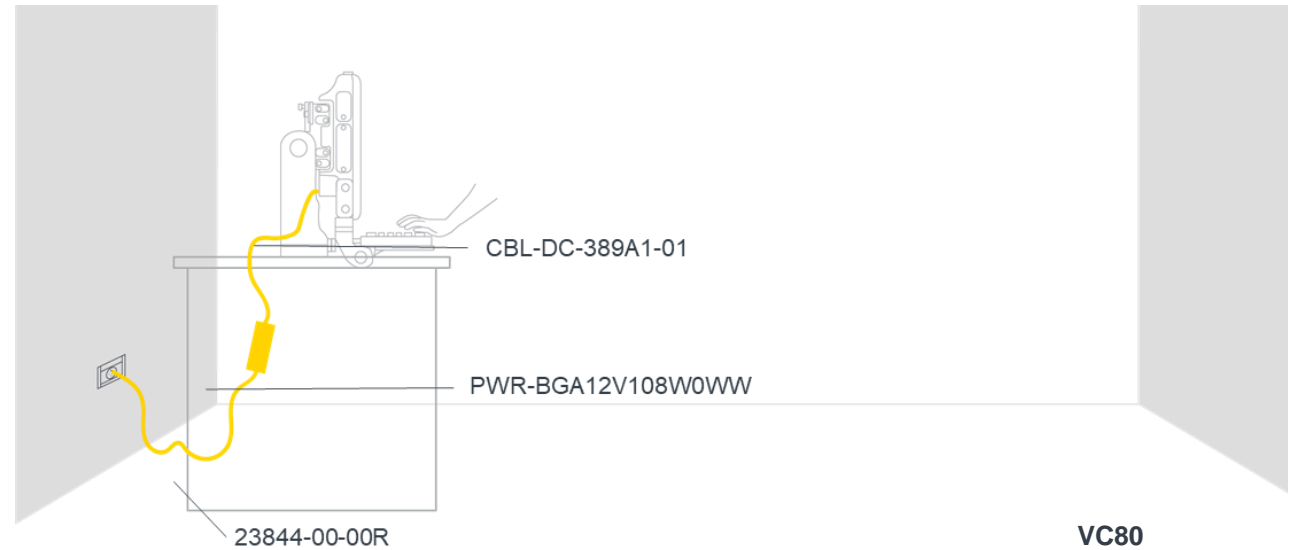

POWERED BY PLUGGING INTO AN AC WALL OUTLET

		VH10	VC70	VC80 VC80x	VC8300
	AC POWER CABLE ID: 23844-00-00R US AC line cord, 7.5 feet long, grounded, three wire for the AC power supplies PS1450 and PWR-BGA12V108W0WW. Associated Countries: United States.	•	•	•	•
	AC POWER SUPPLY for VC70 ID: PWR-BGA12V108W0WW Order country specific 3 wire grounded AC line cord separately.		•		
	DC POWER SUPPLY ADAPTER CABLE for VC70 ID: CBL-DC-389A1-01 6.5', required when the PWR-BGA12V108W0WW is used.		•		
	AC POWER SUPPLY for VH10, VC80, VC80x & VC8300 ID: PS1450 100/240 VAC Power Supply, 12V, 6A, order AC cable separate	•			•
	AC POWER SUPPLY for VC80 and VC80x ID: PWR-BGA24V150W0WW 100/240 VAC Power Supply, 24V, 6.5A, order AC cable separate				•

Step 1:

Power Supplies & Cables

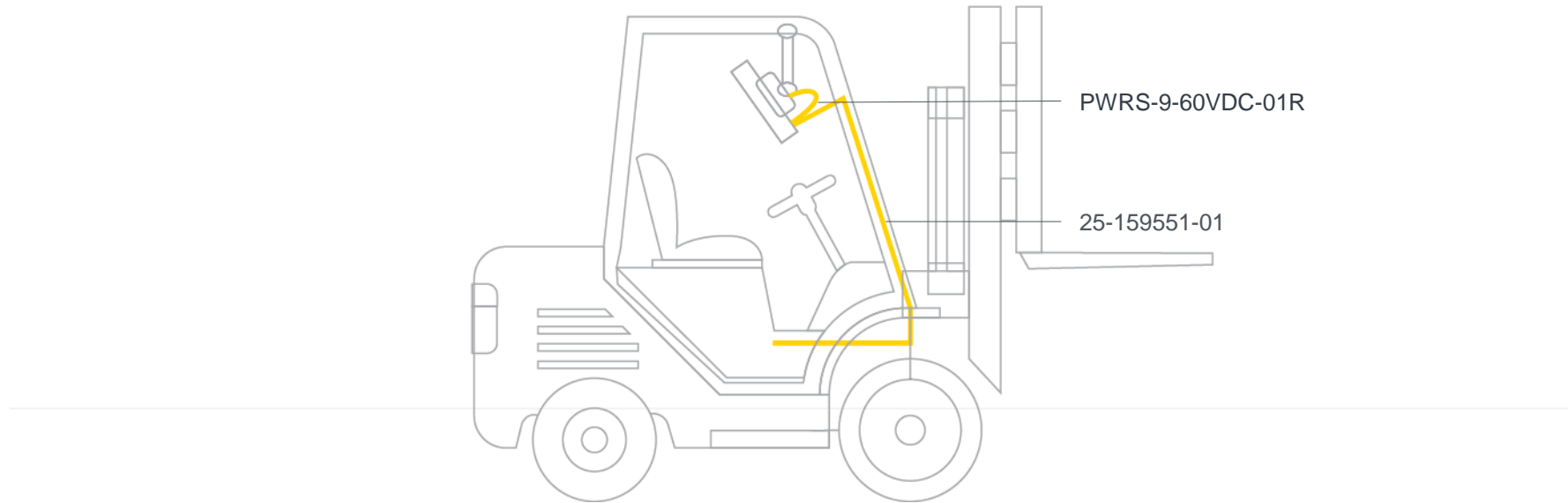

VC70

VEHICLE MOUNT (DC POWER SUPPLY MOUNTED ON THE VC70)

Buy both



DC POWER SUPPLY | ID: PWRS-9-60VDC-01R

External DC Power supply, VC70, 9-60VDC Requires 25-159551-01 fused DC power cable to vehicle battery



DC POWER CABLE | ID: 25-159551-01

Cable, external 9-60V DC power supply to vehicle battery, 10', includes fuse, VC70. Required for the PWRS-9-60VDC-R

Step 1:

Power Supplies & Cables

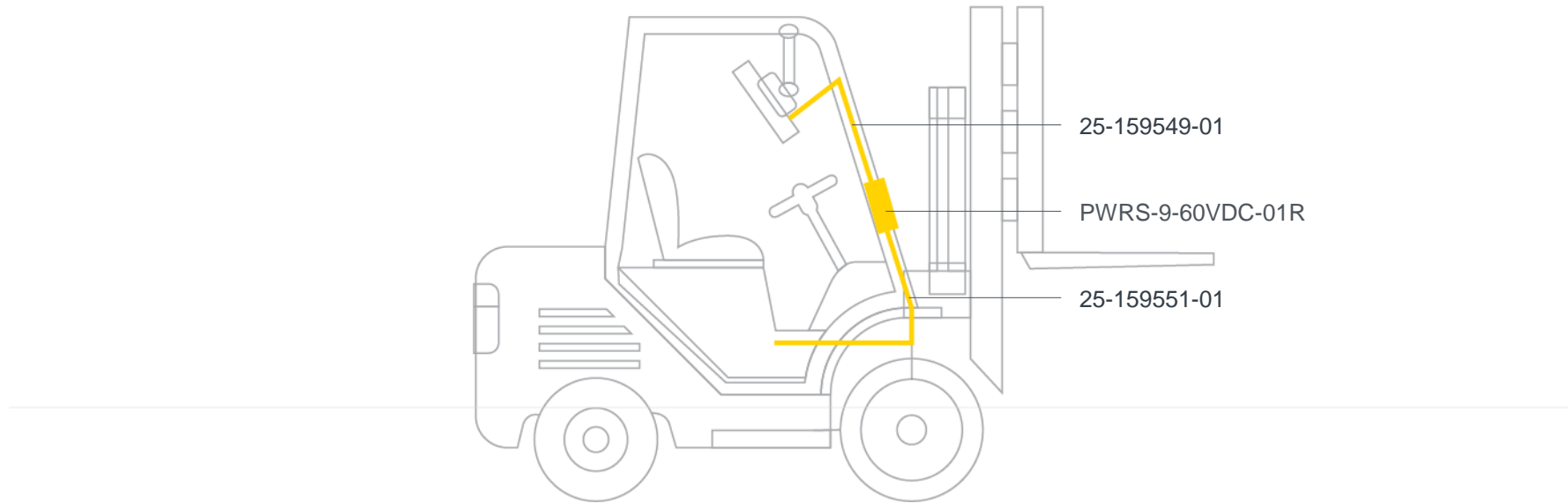

VC70		VEHICLE MOUNT (DC POWER SUPPLY NOT MOUNTED ON THE VC70)
Buy all of these		EXTENSION CABLE ID: 25-159549-01 Cable, external power supply to VC70 extender. 6.5', VC70. Required when the PWRS-9-60VDC-01R is not mounted on the back of the VC70.
		DC POWER SUPPLY ID: PWRS-9-60VDC-01R External DC Power supply, VC70, 9-60VDC Requires 25-159551-01 fused DC power cable to vehicle battery
		DC POWER CABLE ID: 25-159551-01 Cable, external 9-60V DC power supply to vehicle battery, 10', includes fuse, VC70. Required for the PWRS-9-60VDC-R

Step 1:

Power Supplies & Cables

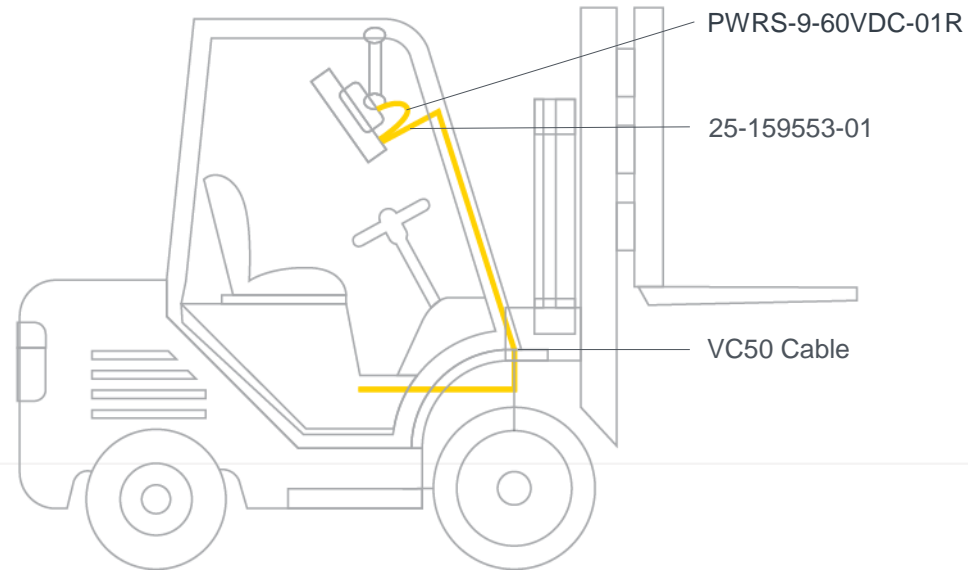

VC70

VEHICLE MOUNT (WHEN REPLACING THE VC50 AND REUSING THE VC50 DC POWER CABLE)

Buy both



DC POWER SUPPLY | ID: PWRS-9-60VDC-01R

External DC Power supply, VC70, 9-60VDC Requires 25-159551-01 fused DC power cable to vehicle battery



POWER ADAPTER CABLE | ID: 25-159553-01

Cable, external power supply to existing VC5090 power cable (25-71919-03R or 25-71919-04R), includes fuses, 2', VC70

Step 1:

Power Supplies & Cables

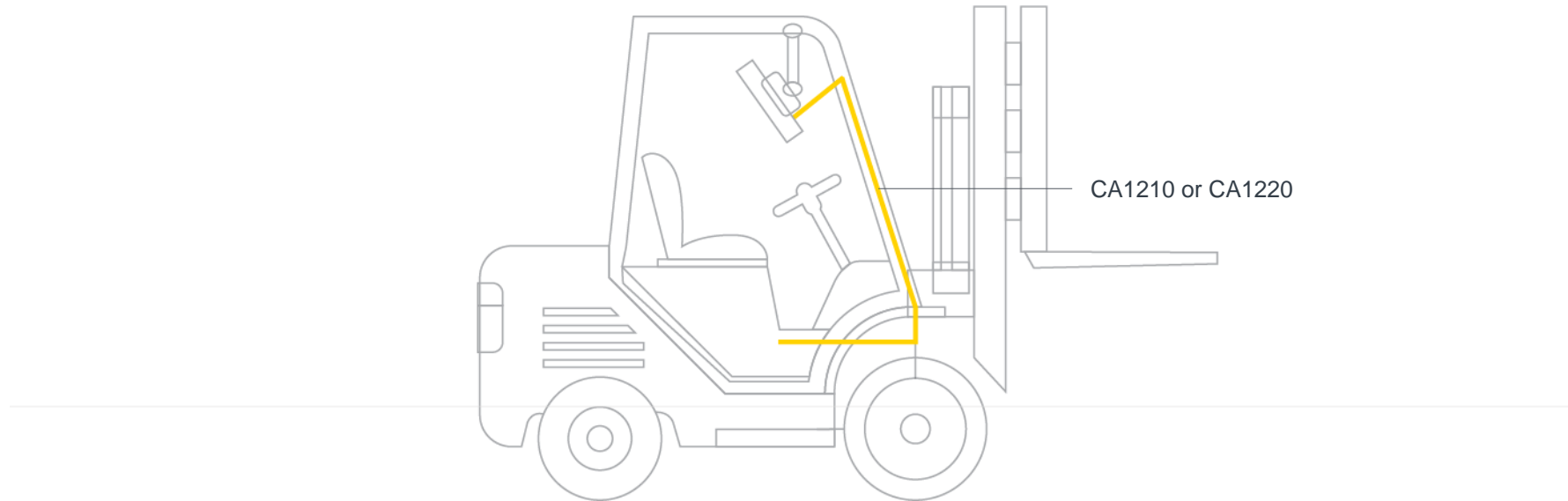

VH10, VC80, VC80x, VC8300

VEHICLE MOUNT (POWER SUPPLY IS INSIDE THE COMPUTER)

Pick one



DC POWER CABLE | ID: CA1210

Power Extension Cable, DC, 6', waterproof



DC POWER CABLE | ID: CA1220

Power Extension Cable DC, 6', waterproof - Includes Screen Blanking feature

Step 1:

Power Supplies & Cables

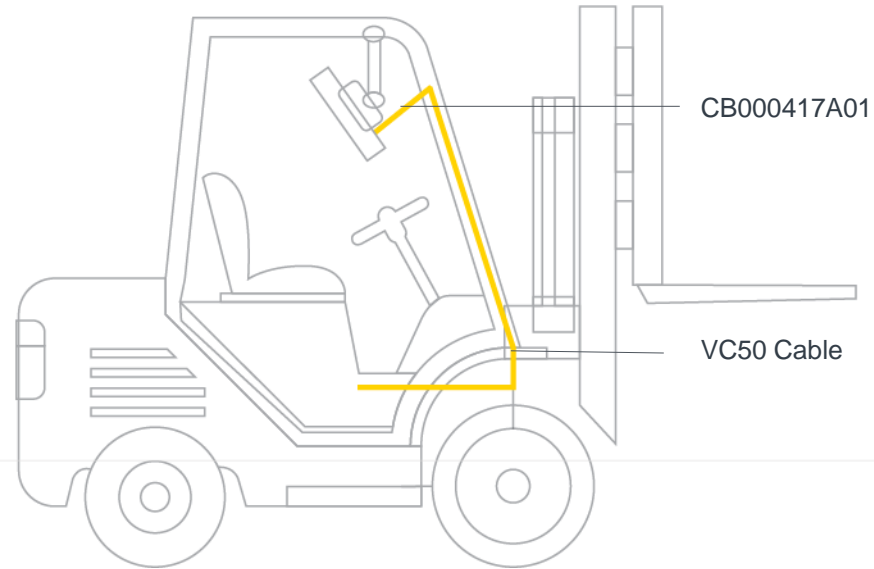

VH10, VC80, VC80x, VC8300

VEHICLE MOUNT (WHEN REPLACING VC50 AND REUSING THE VC50 DC POWER CABLE)



POWER ADAPTER CABLE | ID: CB000417A01
DC Power Adapter to VC50

Step 1:

Power Supplies & Cables

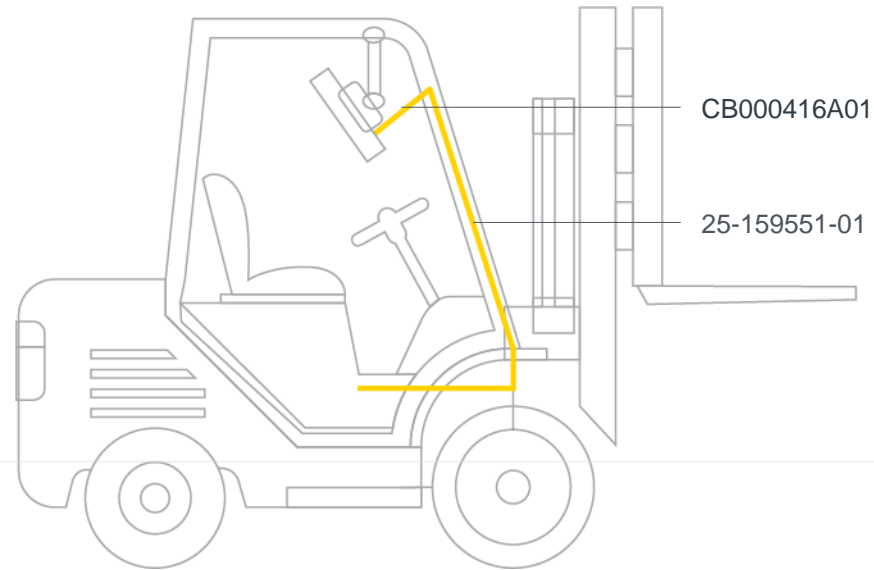

VH10, VC80, VC80x, VC8300

VEHICLE MOUNT (WHEN REPLACING VC70 AND REUSING THE VC70 DC POWER CABLE)



POWER ADAPTER CABLE | ID: CB000416A01
DC Power Adapter to VC70

Step 1:

Power Supplies & Cables

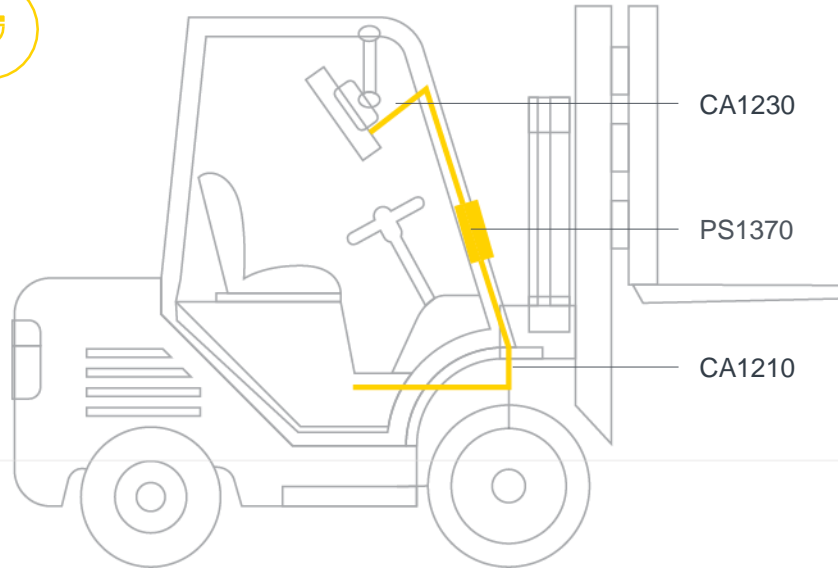

VH10, VC80, VC80x, VC8300

VEHICLE MOUNT (WITH PRE-REGULATOR TO DECREASE VOLTAGE - FOR TRUCKS WITH BATTERIES GREATER THAN 48V)

Buy all three



DC POWER CABLE | ID: CA1230
Power extension cable for pre-regulator with ignition sense



PRE-REGULATOR | ID: PS1370
Pre-Regulator, 24 - 90 VDC in, 15 VDC out, 90 W



DC POWER CABLE | ID: CA1210
Power Extension Cable, DC, 6', waterproof

Step 1:

Power Supplies & Cables

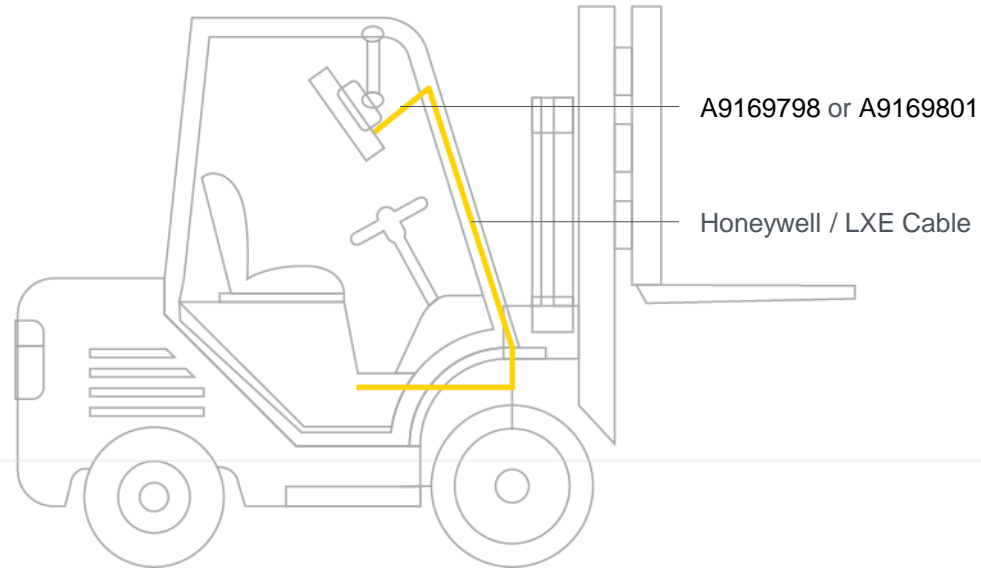

VH10, VC80, VC80x, VC8300

VEHICLE MOUNT (WHEN REPLACING A HONEYWELL/LXE VC AND REUSING THE DC POWER CABLE)



POWER ADAPTER CABLE | ID: A9169798

Adapter CPC to LXE/Honeywell VX8, VX9, VM1, VM2 AND VM3 DC Power Extension Cable



POWER AND SCREEN BLANKING ADAPTER CABLE | ID: A9169801

Adapter CPC and serial to LXE VX8 and VX9 DC Power Extension and Screen Blanking Cable

Step 2:

Mounts



- Your mounting options depend on your computer
 - For VH10, VC80, VC80x, VC8300, choose the following (slides 16/17):
 - RAM Mount
 - Quick-Release Mount
 - Adapter bracket for 82XX mounts
 - Adapter brackets for legacy VCs
 - For the VC70, choose one (slide 18):
 - RAM Mount
 - U Mount
 - Adapter bracket for VC50 mount
 - You can also select a RAM FIXED mount based on your vehicle that works with the VH10, VC70, VC80, VC80x and VC8300 (slide 19)

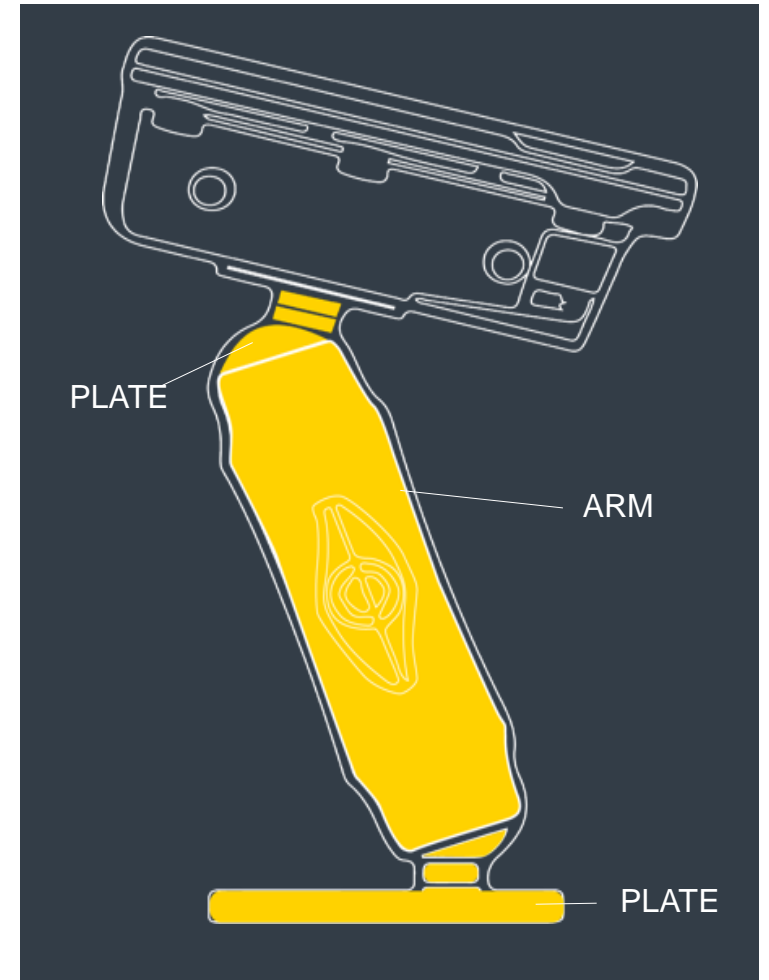

Step 2: Mounts

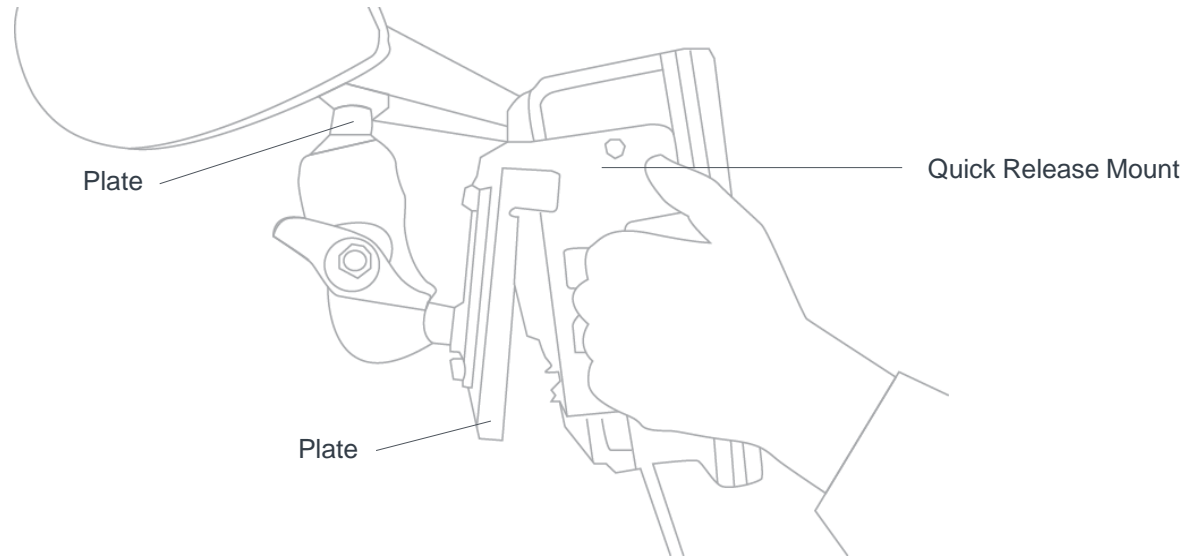

FOR VH10, VC80, VC80x, VC8300

DO YOU NEED A RAM MOUNT, A QUICK RELEASE MOUNT, OR ADAPTERS TO OLD 82XX MOUNTS?



QUICK RELEASE MOUNT | ID: MT4200

Quick release mount. Attaches to the side of the computer and includes Mounting Plate (MT4205) that attaches to forklift.



PLATE | ID: MT4205

Mounting plate for MT4200, Quick Release Mount, needed if you have one computer for multiple trucks



ADAPTER BRACKET | ID: MT4210

Adapter bracket kit for the older 82XX mounts



PLATE | ID: MT3501

VESA plate (for 4" or 12" RAM arm), Can also be attached to Quick Release Mount Plate (MT4205)



PLATE | ID: MT4510

RAM 2"x3" rectangular base with 2.25" rubber ball. Can be attached directly to VH10, VC80, VC80x and VC8300

12

Step 2:

Mounts



FOR VH10, VC80, VC80x, VC8300

DO YOU REPLACE A LEGACY ZEBRA OR HONEYWELL/LXE VC?



ADAPTER FOR VC50 U-MOUNT

| ID: MNT-VC80-ADPA1-1

The adapter brackets for the VC50 U-Mount can be used to replace a VC50 by a VH10, VC80, VC80x or a VC8300 and reuse the existing U-Mount.



U-MOUNT, WITH VC70 U-MOUNT HOLE PATTERN

| ID: KT-U-MOUNT-VC80-R

The VC80 Series U-Mount is smaller than the one for the VC50 and has several mounting holes which allow drop-in replacements of VC70, and DLoG U-Mounts. It provides step less tilting of the VC and comes with the VC50 adapters.



ADAPTER FOR HONEYWELL U-MOUNT

| ID: MNT-VC80-ADPB1-1

The adapter brackets for the Honeywell U-Mount can be used to replace a Honeywell/LXE VC by a VH10, VC80, VC80x or a VC8300 and reuse the existing U-Mount (Honeywell part number VM1010BRKTKIT).

Step 2:



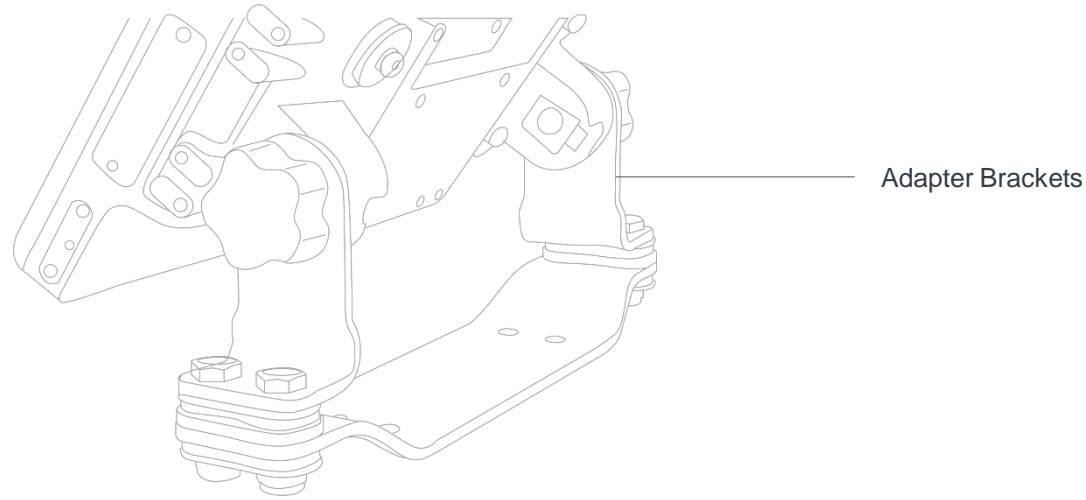

Mounts



Adapter Brackets

FOR THE VC70

DO YOU NEED A RAM MOUNT, AN U MOUNT, OR ADAPTER BRACKETS TO THE VC50 U MOUNT?

	<p>RAM MOUNT ID: RAM-D-2461U-MOTO7 RAM bridge with RAM-D-2461U RAM MOUNT, D (2.25") size ball with screws. Including screws to mount the PWRS-9-60VDC-01R External DC Power Supply. Used when replacing equipment already mounted with RAM mounts</p>
	<p>RAM MOUNT ID: RAM-D-2461U-MOTO7B RAM-D-2461U RAM MOUNT, D (2.25") size ball with screws. Used when the PWRS-9-60VDC-01R External DC Power Supply has to be mounted away or when AC power supply is used. Used when replacing equipment already mounted with RAM mounts</p>
	<p>U MOUNT ID: KT-U-MOUNT-VC70-R U mount, VC70, with mounting hardware</p>
	<p>ADAPTER BRACKET ID: KT-VC50ARM3-VC70-R 2 mount adapter arms for VC50 bracket, 3.5", with bolts</p>
	<p>ADAPTER BRACKET ID: KT-VC50ARM7-VC70-R 2 mount adapter arms for VC50 bracket, 7", with bolts</p>









Step 2:

Mounts



VH10, VC70, VC80, VC80x, VC8300

DEPENDING ON THE VEHICLE, BELOW ARE THE RAM FIXED MOUNTING OPTIONS TO THE COMPUTER AND/OR THE VEHICLE.

	ARM ID: MT4301 RAM mount, 4" arm
	ARM ID: MT4302 RAM mount, 12" arm
	PLATE ID: MT3501 VESA plate (for 4" or 12" RAM arm), Can also be attached to Quick Release Mount Plate (MT4205)
	PLATE ID: MT3502 Round plate (for 4" or 12" RAM arm), Uses smaller footprint than MT3501 VESA Plate
	BASE ID: MT3505 Clamp base (for 4" or 12" RAM arm), 2" max. width
	BASE ID: MT3507 Clamp base (for 4" or 12" RAM arm), 3" max. width
	BASE ID: MT3509 Rail base (for 4" or 12" RAM arm), 1-1/4" to 1-7/8"
	BASE ID: MT3510 Rail base (for 4" or 12" RAM arm), 2" to 2 1/2"
	BASE ID: MT4510 RAM 2"x3" rectangular base with 2.25" rubber ball

Step 3:

Scanners



- When shopping for scanner cables, choose between coiled or straight for your scanner and between an RS232 or USB plug.
- Scanner Cables for LI/DS36XX (slide 21)
- Scanner cables for LS/DS 34XX/35XX (slide 21)
- Scanner holders (slide 22)



Glacier Computer

603.882.1560 Ext. 6

sales@glaciercomputer.com

www.glaciercomputer.com

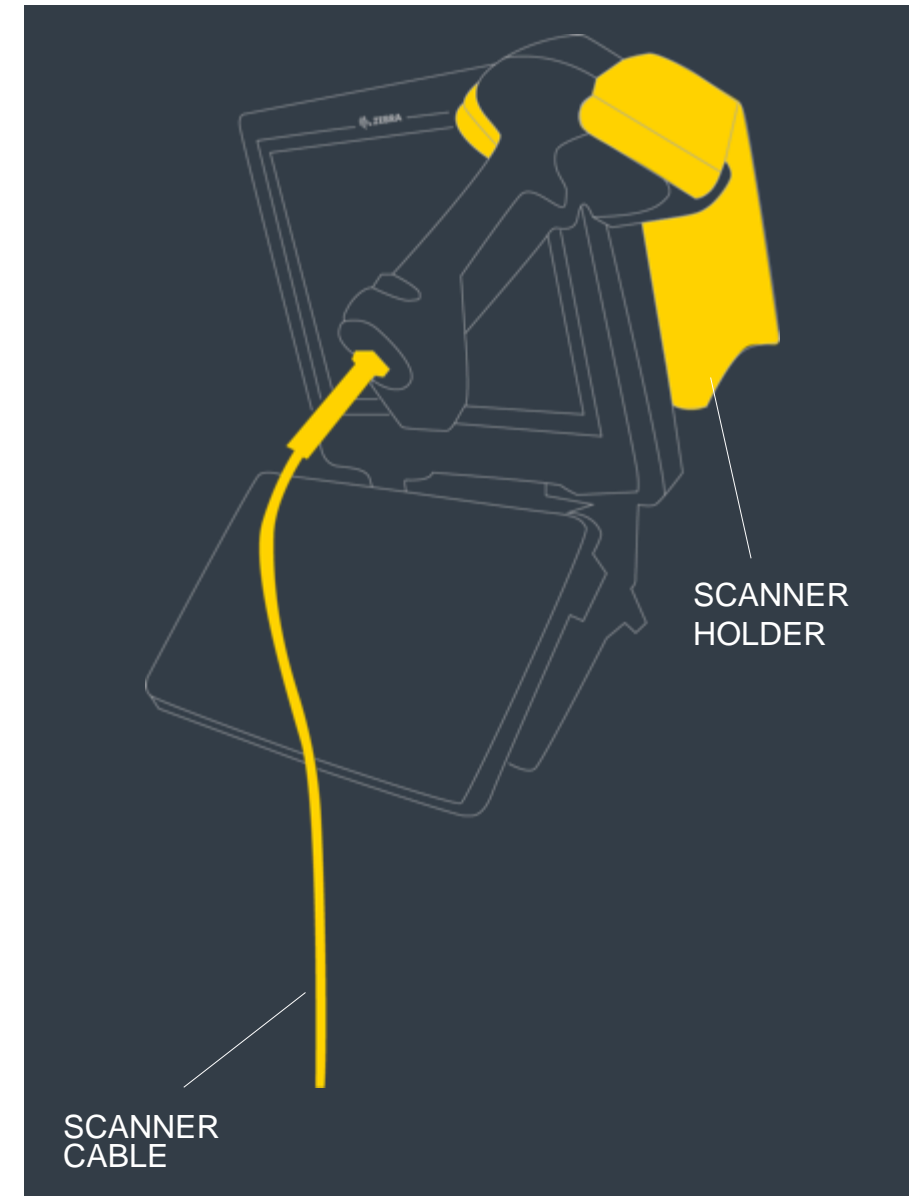

Step 3:

Scanners







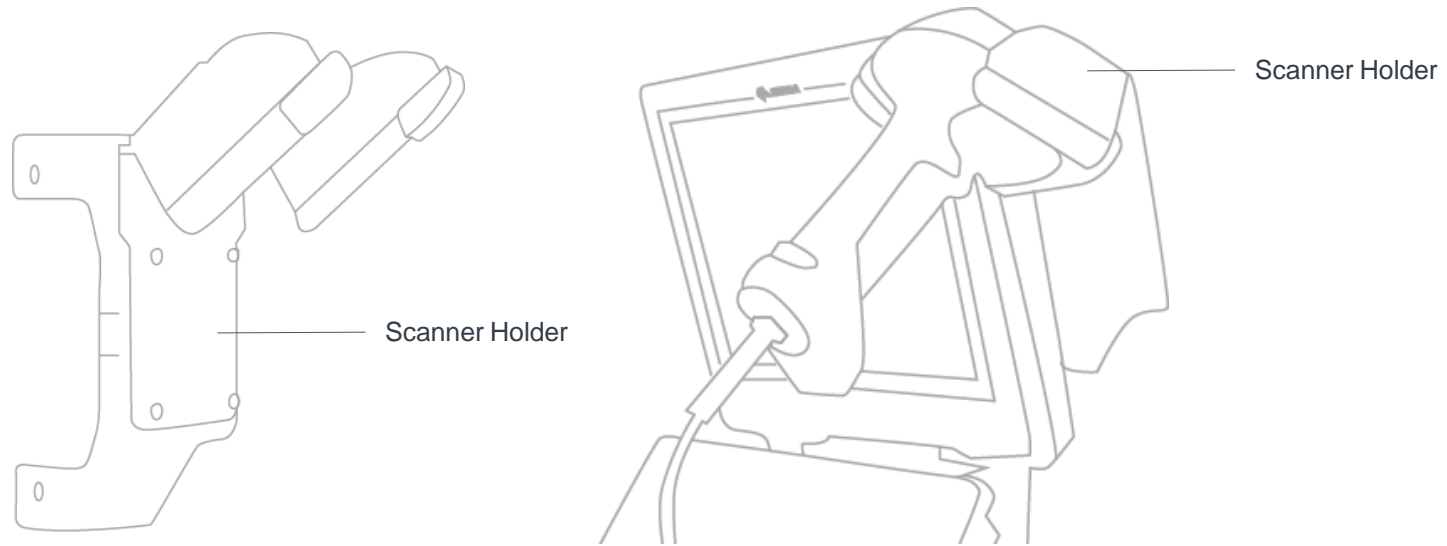

LI/DS36XXXX		SCANNER CABLES			
Photo Not Available	RS232 ID: CBA-RF3-C09ZAR Cable - RS232: DB9 Female Connector, 9ft. (2.8m) Coiled, Power Pin 9, TxD on 2, True Converter, -30C			•	
	SHIELDED USB ID: CBA-UF2-C12ZAR Cable - Shielded USB: Series A Locking Connector for VC70, 12', Coiled, -30C			•	
	RS232 ID: CBA-R71-C09ZAR Cable - RS232: DB9 Female Connector, 9ft (2.8m) Coiled, Power Pin 9	•			•
Photo Not Available	RS232 ID: CBA-RF2-C09ZAR Cable - RS232: DB9 Female Connector, 9ft (2.8m) Coiled, Power Pin 9, -30C	•			•
	SHIELDED USB ID: CBA-U46-S07ZAR Cable - Shielded USB: Series A Connector, 7ft. (2m), Straight, BC 1.2	•			•
Photo Not Available	SHIELDED USB ID: CBA-U47-S15ZAR Cable - Shielded USB: Series A Connector, 15ft. (4.6m), Straight, BC 1.2	•			•
Photo Not Available	SHIELDED USB ID: CBA-UF1-S07ZAR Cable - Shielded USB: Series A Connector, 7ft. (2m), Straight, BC 1.2, -30C	•			•
LS/DS 34XX/35XX		SCANNER CABLES			
	SHIELDED USB ID: 25-159548-01 Cable - Shielded USB: Series A Locking Connector for VC70, 12', Coiled, -30C			•	
Photo Not Available	RS232 ID: CBA-R46-C09ZBR Cable - RS232: DB9 Female Connector, 9ft. (2.8m) Coiled, Power Pin 9, TxD on 2, True Converter			•	
Photo Not Available	RS232 ID: CBA-R49-C09ZAR Cable - RS232: DB9 Female Connector, 9ft. (2.8m) Coiled, Power Pin 9, TxD on 2, True Converter, Low Temp -30C			•	
	RS232 ID: CBA-R37-C09ZAR Cable - RS232: DB9 Female Connector, 9ft (2.8m) Coiled, Power Pin 9	•			•
Photo Not Available	USB ID: CBA-U09-C15ZAR Cable - USB: Series A Connector, 15ft. (4.6m) Coiled	•			•
Photo Not Available	SHIELDED USB ID: CBA-U01-S07ZAR Cable - Shielded USB: Series A Connector, 7ft. (2m), Straight, BC 1.2	•			•
Photo Not Available	SHIELDED USB ID: CBA-U10-S15ZAR Cable - Shielded USB: Series A Connector, 15ft. (4.6m), Straight, BC 1.2	•			•

Step 3:

Scanner Holders



		VH10	VC8300	VC70	VC80 VC80x
	SCANNER HOLDER ID: KT-SCANMNT-VC70-R Mounting holder for the scanner. For LS34x8ER, LS35x8ER. Requires KT-ACCMNT-VC70-R Accessory side mount bracket				
	ACCESSORY MOUNT ID: KT-ACCMNT-VC70-R Accessory side mount bracket			•	
	SCANNER HOLDER ID: KT-SCANMNT-VC80-R Side mounted holder for scanner		•		•

Step 4:

Keyboards

- While the VH10 and the VC8300 have built-in keyboards, the VC70, VC80 and VC80x give you multiple options
 - VC80 and VC80x Keyboards (slide 24)
 - VC70 Keyboards (slide 25)

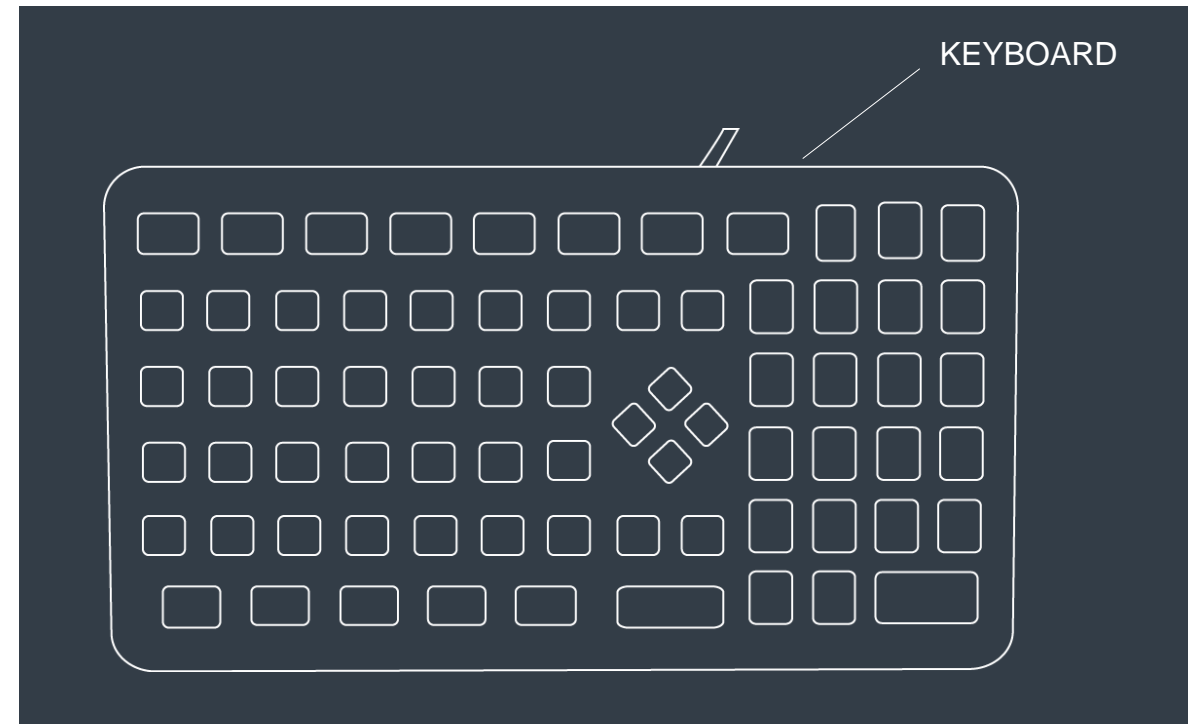

Step 4:

VC80 & VC80x Keyboards, Cables and Mounting Options



KEYBOARD | ID: KYBD-AZ-VC-01
VC USB Keyboard AZERTY



KEYBOARD | ID: KYBD-QW-VC80-S-1
USB Keyboard QWERTY with 22 cm cable for VC80/VC80x



KEYBOARD | ID: KYBD-QW-VC80-L-1
USB Keyboard QWERTY with 300 cm cable for VC80/VC80x



KEYBOARD CABLE | ID: CBL-VC80-KBUS1-01
22 cm VC80 Series USB cable for heated Keyboard



KEYBOARD CABLE | ID: CBL-VC80-KBUS2-01
300 cm VC80 Series USB cable for heated Keyboard



KEYBOARD | ID: KYBD-NU-VC70-03R
USB Keyboard QWERTY with 300 cm y-cable for VC70 Freezer



KEYBOARD TRAY | ID: KT-KYBDTRAY-VC80-R
QWERTY/AZERTY Keyboard mounting tray. Includes tilting arms, knobs and screws.



KEYBOARD SIDE MOUNT BRACKET | ID: KYBD-NU-VC80-03R
Function/Numeric keypad side mount bracket

Step 4:

VC70 Keyboards, Cables and Mounting Options



KEYBOARD | ID: KYBD-AZ-VC-01
VC USB Keyboard AZERTY



KEYBOARD | ID: KYBD-QW-VC70-S-1
USB Keyboard QWERTY with 18 cm cable for VC70



KEYBOARD | ID: KYBD-QW-VC70-L-1
USB Keyboard QWERTY with 300 cm cable for VC70



KEYBOARD | ID: KYBD-QW-VC70F-S-1
USB Keyboard QWERTY with 37 cm y-cable for VC70 Freezer



KEYBOARD | ID: KYBD-QW-VC70F-L-1
USB Keyboard QWERTY with 300 cm y-cable for VC70 Freezer



KEYBOARD CABLE | ID: CBL-VC70-KBUS1-01
18 cm VC70 USB cable for heated Keyboard



KEYBOARD CABLE | ID: CBL-VC70-KBUS2-01
300 cm VC70 USB cable for heated Keyboard



KEYBOARD CABLE | ID: CBL-VC70-KBUS4-01
37 cm VC70 USB & RS232 Y-cable for heated Keyboard



KEYBOARD CABLE | ID: CBL-VC70-KBUS4-01
300 cm VC70 USB & RS232 Y-cable for heated Keyboard



KEYBOARD | ID: KYBD-NU-VC70-03R
USB Keyboard QWERTY with 300 cm y-cable for VC70 Freezer



KEYBOARD TRAY | ID: KT-KYBDTRAY-VC70-3
QWERTY/AZERTY Keyboard mounting tray. Includes tilting arms, knobs and screws.



KEYBOARD SIDE MOUNT BRACKET | ID: KT-KYBDMNT-VC70-R
Function/Numeric keypad side mount bracket

Step 5:

Antennas





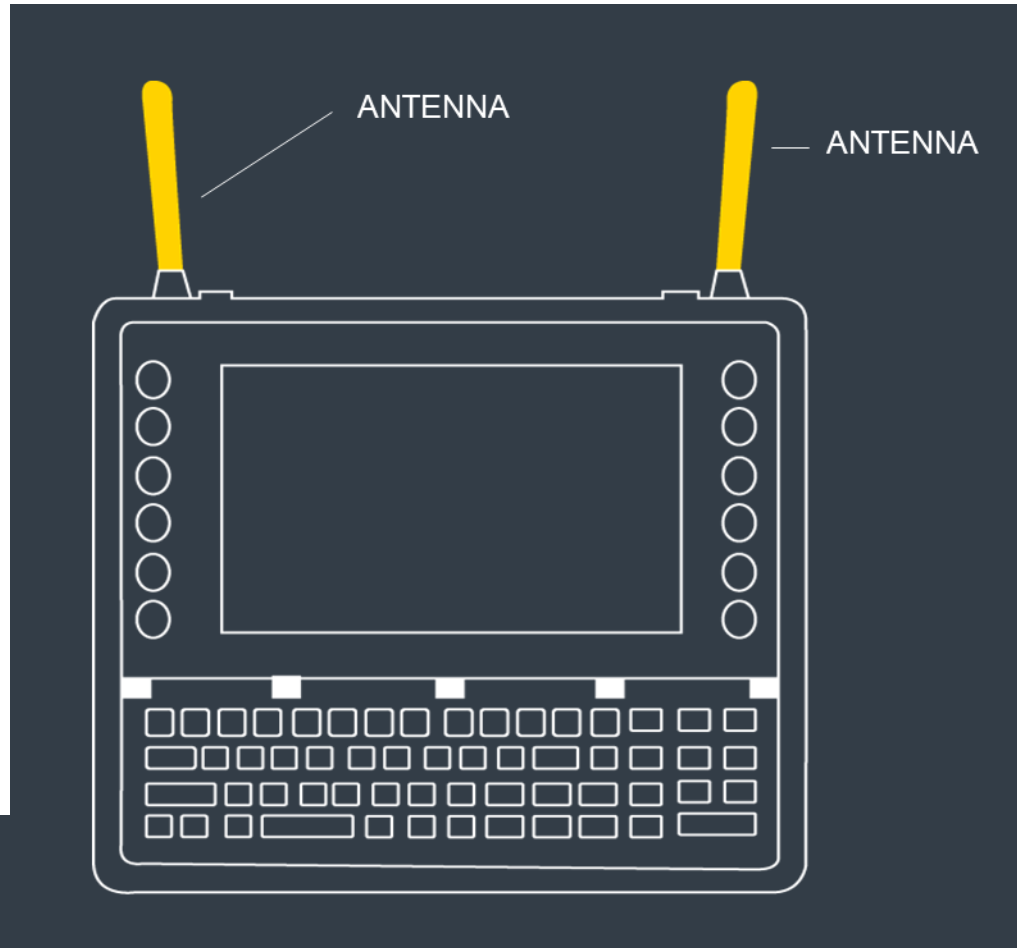



- Your options of antennas are wide (slides 27/28):
 - Wi-Fi: VH10, VC70, VC80, VC80x, VC8300
 - Narrowband: VH10 Only
 - GPS: VC80 Only
 - Right-angle adapter for installations with little overhead space
 - VH10, VC70, VC80, VC80x, VC8300



Step 5:

Antennas & Connectivity to choose from





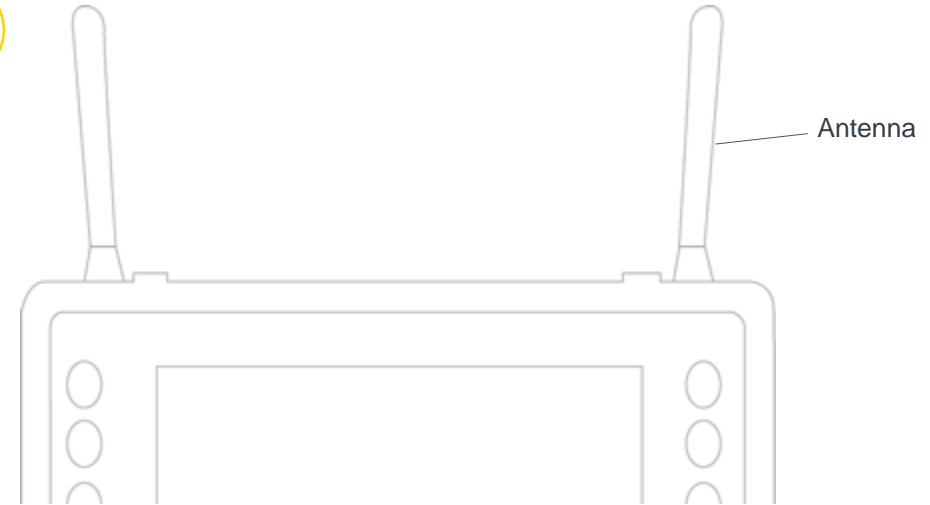

ALL VCS	ANTENNAS & CONNECTIVITY FOR WIFI
	ANTENNA ID: 20667-002 Whip antenna (stubby), 802.11 b/g - dipole 2 dBi reverse polarity SMA connector
	ANTENNA ID: AN2010 Antenna, dual band, 802.11 a/b/g/n, 2 dBi, RPSMA connector, magnetic mount, 2.9m
	ANTENNA ID: AN2020 Antenna, 2.4 GHz, 802.11 b/g, 5 dBi, RPSMA connector, magnetic mount, 2.9m
	ANTENNA ID: AN2030 Whip antenna (stubby), dual band, 802.11 a/b/g/n, 2.4GHz 2dBi, 5GHz 3.7 dBi, RPSMA connector, WiFi
VC70	ADAPTERS FOR VC70 TO ATTACH EXTERNAL WIFI ANTENNAS WITH RPSMA CONNECTOR
	ADAPTER ID: RPSMA-RTRPSMA-05R ANTENNA ADAPTER RPSMA - RTRPSMA, 5-PACK, Required for the VC70 WiFi Antennas
	ADAPTER ID: RPSMA-RTRPSMA-10R ANTENNA ADAPTER RPSMA - RTRPSMA, 10-PACK, Required for the VC70 WiFi Antennas

Step 5:

Antennas & Connectivity to choose from



VH10	ANTENNAS & CONNECTIVITY FOR NARROWBAND
	ANTENNA ID: 9009801 Antenna, Narrow Band 1/4 wave, 406-512 MHz 6" NB
	MOUNT ID: 9009792 Mount, Magnetic, for Narrowband, antenna, SMA, 12' cable
VC80	ANTENNA FOR GPS
	ANTENNA ID: AN000090A01 GNSS antenna, magnetic mount, 2.9 m cable
ALL VCS	RIGHT ANGLE ADAPTER FOR INSTALLATIONS WITH LITTLE SPACE OVERHEAD, ALL VCS
	RIGHT ANGLE ADAPTER ID: AR1000 Right Angle SMA reverse polarity plug-jack Adapter

Step 6:

Voice

- Select from turnkey kits or voice accessories A LA Carte.
- Your Voice options (slide 30)
 - Voice

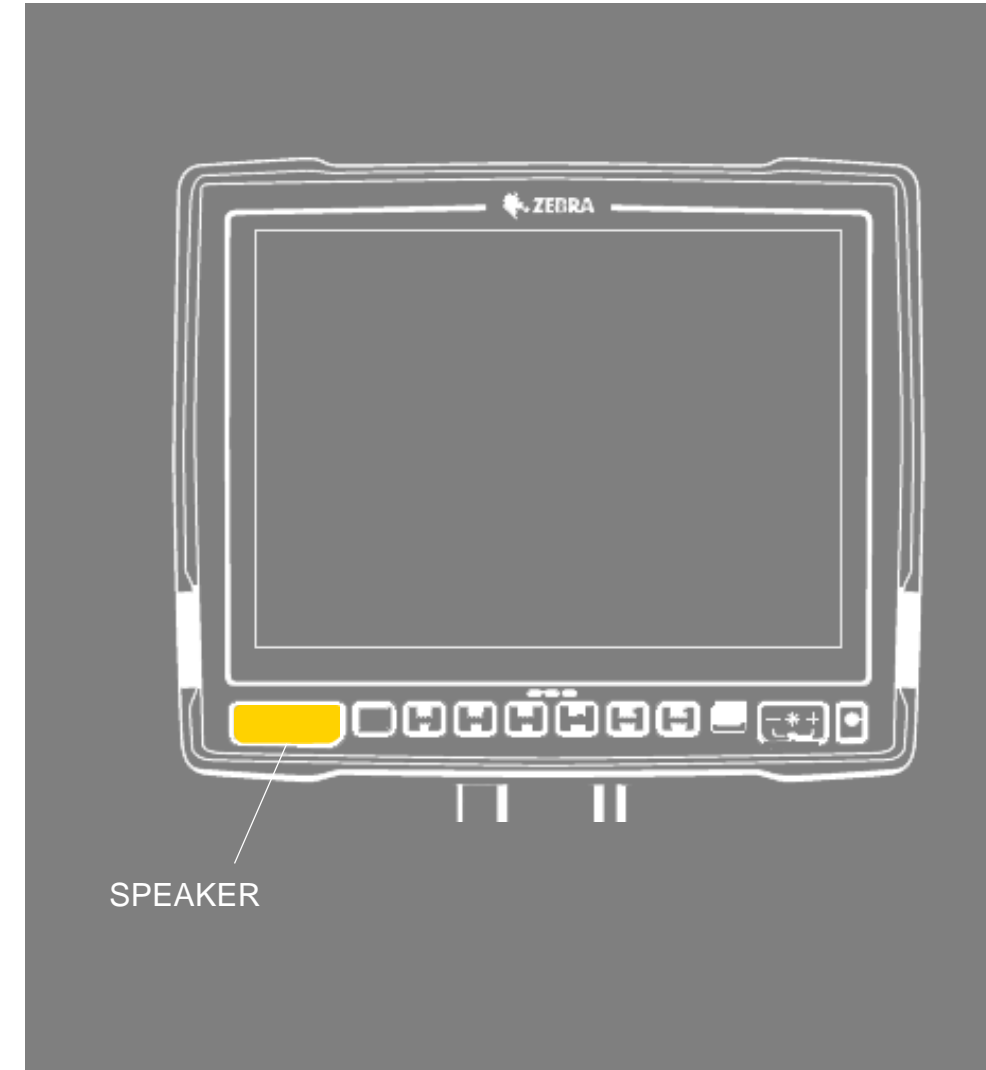
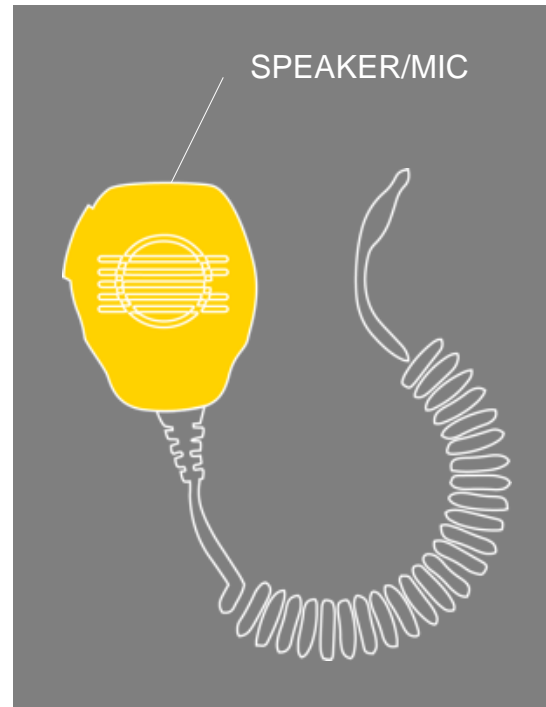

Step 6:

Voice



		VH10	VC8300	VC70	VC80 VC80x
Photo Not Available	MICROPHONE KIT ID: KT-MIC-01R This bundle includes the VC70 External PTT mic, the Motorola HMN1089B Water-resistant Palm Microphone or equivalent and the KT-ACCMNT-VC70-R Accessory Side mount bracket.			•	
	MICROPHONE ID: HMN1089B Push-To-Talk Hand Microphone, GCAI connector, Water Resistant			•	
	SIDE MOUNT ID: KT-ACCMNT-VC70-R Accessory Side mount bracket			•	
Photo Not Available	SPEAKER KIT ID: KT-SPKR-01R This bundle includes the External speaker, the Motorola HSN4039A 13 Watt water-resistant loudspeaker and the 25-159552-01 VC70 external speaker adapter cable.			•	
	SPEAKER ID: HSN4040A External speaker, Motorola HSN4040A 13 Watt water-resistant loudspeaker. Requires 25-159552-01			•	
	INTERFACE CABLE ID: 25-159552-01 Speaker cable adapter, for HSN4040A, VC70. Required to connect the HSN4040A external speaker.			•	
	SPEAKER/MIC ID: M1000 Speaker/Mic with push-to-talk function	•			•

Step 7:

Miscellaneous



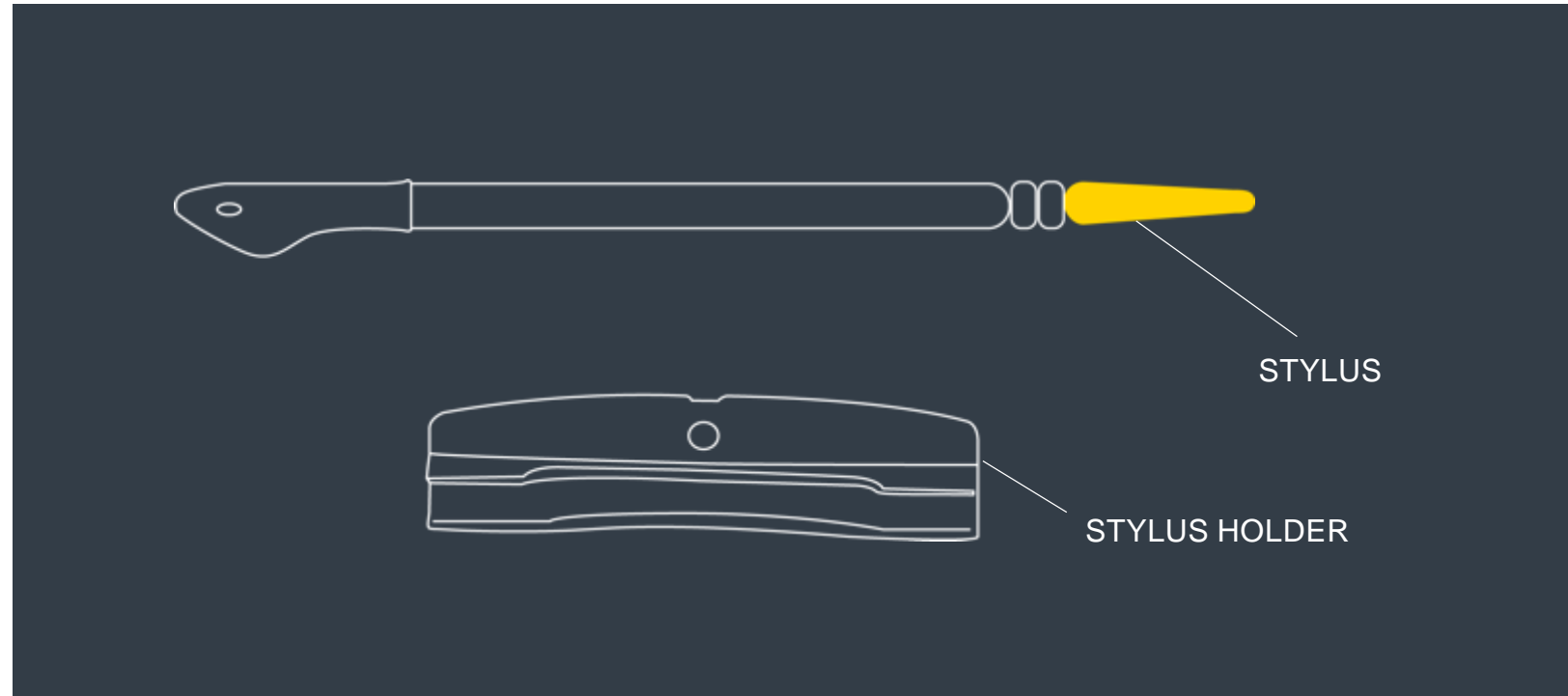









- Don't forget to consider the following accessories (slide 32)
 - Stylus
 - Screen protector
 - CAN BUS cable
 - USB to Ethernet adapter



Step 7:

Miscellaneous



		VH10	VC8300	VC70	VC80	VC80x
	ID: SL0001 Stylus and Stylus Holder	 •	 •	 •	 •	 •
	ID: VA6200 Screen Protector Pack of 3	•				
	ID: KT-SPRTCT-VC70-05R Screen Protector Pack of 5			•	•	•
	ID: CA1300 Screen blanking cable (DB9 to open wires)	•	•		•	•
	ID: CB-000433-01 CAN Bus Cable (RJ45 to Deutsch)				•	
	ID: WA4070 USB to Ethernet Adapter	•	•		•	•
	ID: 25-159547-01 Cable DB15M to DB9M, for COM2			•		
	ID: SG-VC70-VISR1-01 VC70 Sun Visor mountable with cut out wing.			•		
Photo Not Available	ID: KT-AREFL-VC83-8-1 Anti Reflection Foil		•			

Step 8:





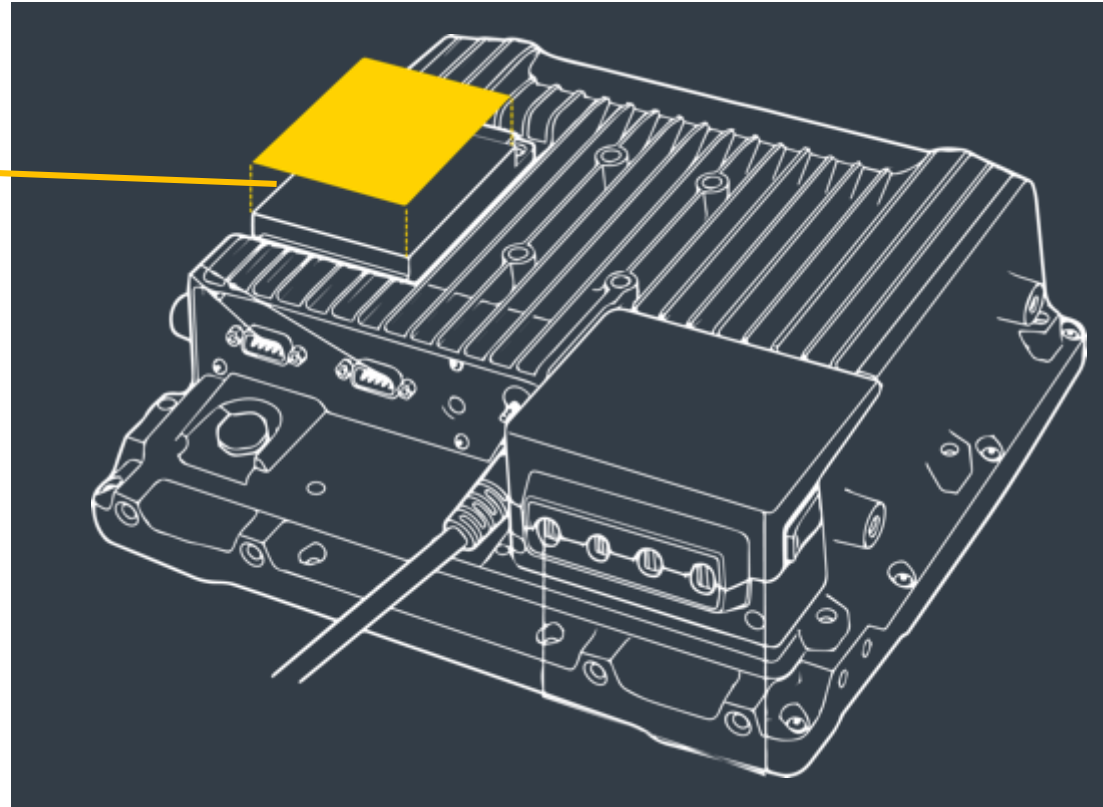

Service Parts

- Stock up on these essential spare parts (slides 34/35)
 - Tool kit
 - Keypads
 - Touch screens
 - Spare battery







Step 8:

Service Parts

SERVICE PARTS		VH10	VC8300	VC70	VC80 VC80x
Photo Not Available	ID: AL1001 QWERTY Keypad	 •			
Photo Not Available	ID: AL1002 AZERTY Keypad	•			
Photo Not Available	ID: AL2002 Front with standard touch screen and function keys	•			
Photo Not Available	ID: AL2002 Front with heated touch screen and function keys	•			
	ID: ST2000 Modular Services Kit	•	•		•
Photo Not Available	ID: KT-VC80-BTRY1-01 Spare Battery		•		•
Photo Not Available	ID: KT-VC80-SCRH1-01 Front with Touch Screen (heated)				•
	ID: KT-VC80-SCRN1-01 Front with Touch Screen (non-heated)				•
Photo Not Available	ID: BTRY-VC70IAB00 Spare Battery			•	
Photo Not Available	ID: KYBD-QW-VC-01 QWERTY Spare Elastomer for VC USB Keyboard			•	•
Photo Not Available	ID: KYBD-AZ-VC-01 AZERTY Spare Elastomer for VC USB Keyboard			•	•

Step 8:

Service Parts

SERVICE PARTS		VH10	VC8300	VC70	VC80 VC80x
	ID: SPR-SMA-DC-10 SMA antenna connector dust caps, pack of 10	 •	 •	 •	 •
	ID: TBD QWERTY Keypad		•		
	ID: TBD AZERTY Keypad		•		
	ID: TBD Front with standard touch screen and function keys		•		
	ID: TBD Front with heated touch screen and function keys		•		



Glacier Computer
 603.882.1560 Ext. 6
sales@glaciercomputer.com
www.glaciercomputer.com